



siegling transilon
conveyor and processing belts

PRODUCT RANGE



SIEGLING TRANSILON FOR LIGHT MATERIALS HANDLING

Under the Siegling Transilon brand name, Forbo Siegling has developed a product line of 600 different designs worldwide that consistently reflects market requirements. Many of the types are based on joint development with users and OEMs.

From rugged "jacks-of-all-trades" to high-tech "specialists": the Siegling Transilon product line offers a wide range of types for the most varied of conveying tasks in all industries, while at the same time also carrying out processing tasks. Special literature is available for many of the topics and industries mentioned in this brochure.

The conditions under which conveyor and power transmission belts are used are seldom identical. So when using Siegling Transilon, take advantage of the experience and competence of your Forbo Siegling consultant.

Contents

- 3 Siegling Transilon for light materials handling
- 4 Siegling Transilon for all conveying and processing jobs
- 8 Siegling Transilon product structure
- 9 Siegling Transilon patterns
- 10 Special features and properties
- 11 Special processing
- 12 Siegling Transilon splicing techniques

The properties

The advantages

virtually stretchless	▶	small take-up ranges, economical
longitudinally flexible	▶	small drum diameters, energy-saving
dimensionally stable	▶	maintenance-free, reliable operation
low-noise	▶	humane working conditions
long product life	▶	economical
light and thin	▶	easy to handle, cost-saving design

SIEGLING TRANSILON FOR ALL CONVEYING AND PROCESSING JOBS

Horizontal conveying

Even a conveying task which seems quite simple can require a whole host of belt properties. Forbo Siegling has the best belt type for various goods, conveying speeds, reversing systems, stop & go and accumulation conveying, and other operating conditions. Some examples of the diverse features of Siegling Transilon include:

- troughable to particularly laterally stiff types
- exceptionally low-noise to flame-retardant
- pyrolysis-resistant to suitability for conveying unpackaged food
- non-antistatic to highly conductive and ATEX-approved
- surfaces suitable for accumulation conveying and especially good grip.



Collecting belt in check-in area of an airport. The flatness of the belt type here ensures that the goods can be discharged to the side smoothly, even on wide belts. Flame-retardance is a “must” in modern airports.



Horizontal conveying with troughable belts. The tension member construction provides the flexibility in the desired direction.



Belts for telescopic conveyors – here being used to unload lorries – must be designed to run with counter bending and at the same time, to withstand high punctual loads.

Inclined conveying

Goods can be conveyed at an incline even on smooth belt surfaces. The conveying angle is dependent on a variety of factors such as the type of goods being conveyed, the top face coating and external factors like dust, moisture, etc.

For large conveying angles and for the conveying of small pieces and bulk goods, Forbo Siegling offers patterned belts or belts equipped with lateral profiles.



Inclined conveying in the tobacco industry. In this area, conveying angles of up to 22° are possible for belt types with smooth surfaces.

Curved conveying

Curved belts from Forbo Siegling are suitable for use in conjunction with a diverse array of belt tracking systems and are in use on the conveyors of numerous major manufacturers.

Thanks to largely-automated fabrication, we guarantee strict adherence to the geometrical shapes and dimensions required when supplying finished belts.

Dividing curves into several segments makes for a favourable distribution of force vectors in the belt so even heavy goods can be carried without any problems.



Curved conveyor in a distribution centre.

Collection and distribution

When pushers and ploughs are used, the belt's laterally stiff design guarantees that it will lie flat and continue to run in a straight line reliably. The lateral loading and discharge of goods is achieved by using very smooth, wear-resistant surfaces. Lateral sorters (e.g. carrier cells), on the other hand, require very thin, flexible belts whose surfaces have high coefficients of friction.

Their special tension member construction means that they have very low energy consumption.



Lateral sorter in a distribution centre. The high acceleration requires the belt surface to have an extremely high coefficient of friction.



Processing belts

With Siegling Transilon, the gap is often bridged between the classical conveying function from "A" to "B" and an active function in the production process.

For example, in the textile industry our processing belts stack thin layers of web, in large bakeries they form balls of dough, in the wood industry they compress chip mat in the pre-press, in dairies milk is coagulated on the belts to form cheese.

Here are just a few examples of process operations.



Cross-lapping of web layers in the nonwoven industry. High production speed and acceleration of masses while the web is guided directly between the belts places extremely high demands on the processing belts.

On the left: Pre-press belt in the manufacture of particle boards. The particle mat is pre-pressed while being conveyed.



In large bakeries balls of dough are formed as a result of differing belt speeds.

SIEGLING TRANSILON PRODUCT STRUCTURE

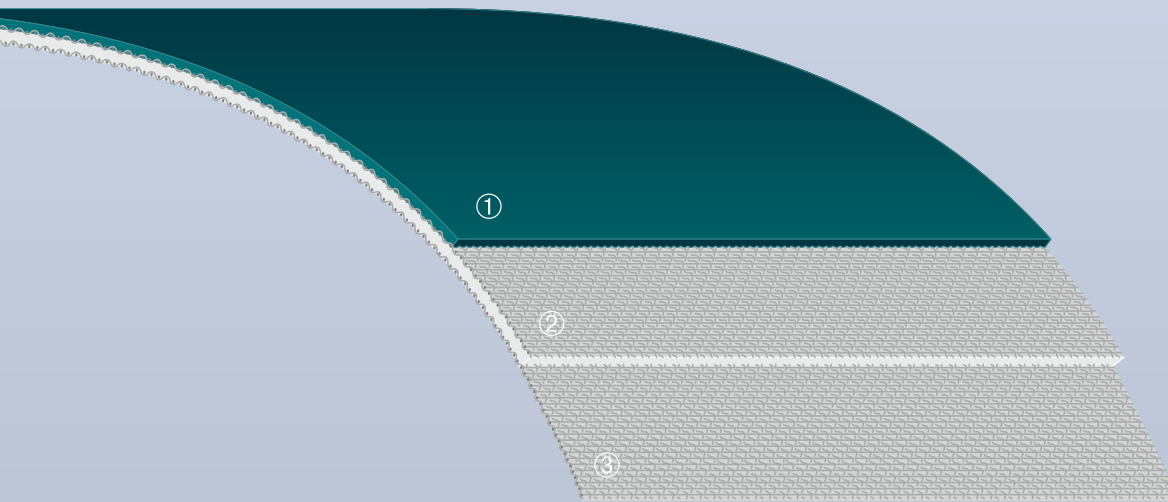

Top face ①

Various coating materials, thicknesses and patterns determine grip, chemical, physiological and mechanical properties of the belt.

Tension member ②

The use of various special fabrics largely determines the suitability for specific applications. Belt tracking properties, load/elongation properties, electrostatic properties, flatness, knife edge and curve suitability are directly dependant on the fabric construction.

Underside ③

The design of the underside determines the noise emission, wear, and suitability for sliding-or rolling support of the belt.

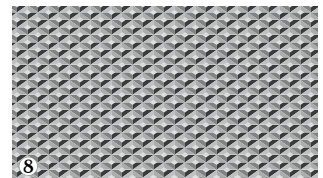
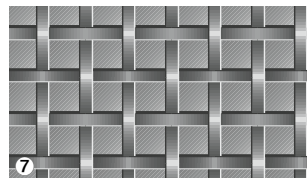
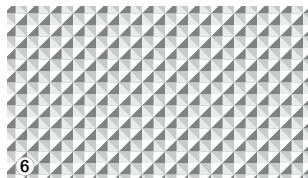
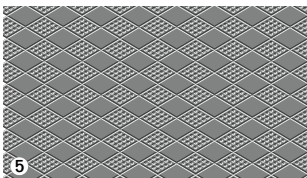
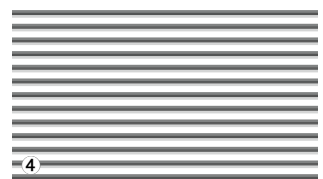
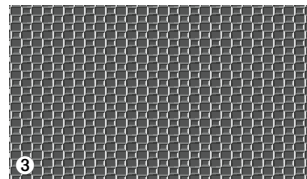
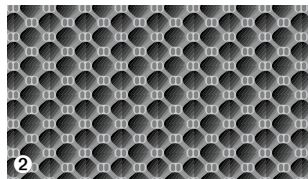
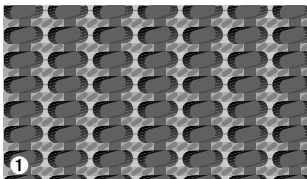

SIEGLING TRANSILON PATTERNS

Forbo Siegling has developed and optimised a wide range of surface patterns for very different applications. The appropriately optimised surface patterns ensure for example, ideal grip with demanding goods such as roller suitcases and good release properties with dough and are also used to emboss manufacturer-specific patterns on the underside of chocolate.

Siegling Transilon patterned belts can run at incline angles of up to 30° without profiles. For larger incline angles they can also be fitted with profiles and sidewalls (see page 11).

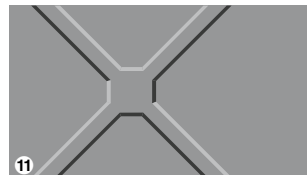
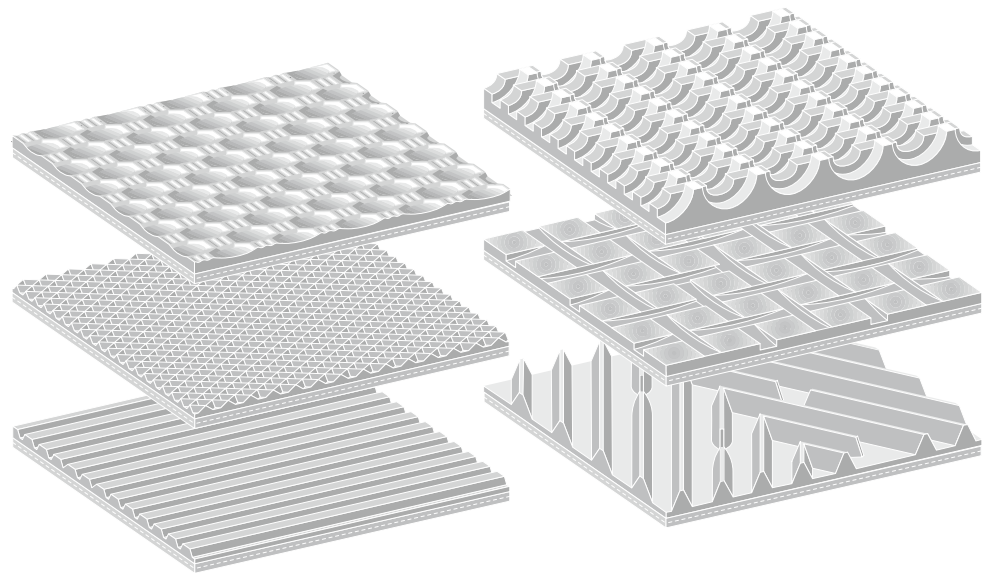

- ① **AR** anti-skid pattern (M 1:1)
- ② **GSTR** coarse textured pattern (M 1:1)
- ③ **STR** normal textured pattern (M 1:1)
- ④ **LG** longitudinal groove (M 1:1)
- ⑤ **RFF** fine rhomboid pattern (M 1:1)
- ⑥ **NP** inverted pyramid pattern (M 1:1)
- ⑦ **SG** lattice pattern (M 1:1)
- ⑧ **RF** fine rhomboid pattern (M 1:1)
- ⑨ **VN** vertical stud pattern (M 1:2)
- ⑩ **KN** cross-stud pattern (M 1:1)
- ⑪ **R80** rhomboid pattern (M 1:2)
- ⑫ **FG** herringbone pattern (M 1:2)
- ⑬ **RPH** high round profile pattern (M 1:2)
- ⑭ **CH** check-in pattern (M 1:4)

SPECIAL FEATURES AND PROPERTIES



Electrical properties

In numerous conveying and processing functions, the electrical properties of the belt material are important for smooth operation. As a standard, Siegling Transilon belts are equipped with a conductive tension member which prevents electrostatic build-up in the belt.

Siegling Transilon non-antistatic belts (NA) are not electrically conductive. They facilitate special engineering solutions for production conveyors where high frequencies are used or regulation is carried out electromagnetically e.g. in security screening and in quality control.

Siegling Transilon highly conductive belts (HC) can also divert electrostatic build-up in the goods conveyed because of their highly conductive coating and/or the tension member. For the safe conveying of electrical components and other electronically sensitive goods.



Food safety

Thanks to numerous product innovations, Forbo Siegling contributes significantly to the hygienic conditions in the sensitive production areas of the food industry. This supports you in implementing your HACCP concept. And users and end users know food has been produced safely.

FDA/EU: All materials used in our food types comply with the FDA 21 CFR, (EU) 10/2011 and (EC) 1935/2004 regulations on the materials used and migration thresholds.

Halal: In the food segment, the majority of the Siegling Transilon PU- and PVC-types are certified as complying with Halal regulations by IFRC Asia (a member of the World Halal Council).

Further special products

In addition to these patterns and features of conveyor and processing belts, Forbo Siegling offer numerous special developments for various applications including:

- belts resistant to UV
- belts with silicone coatings
- flame-retardant belts
- belts for hot goods
- silent belts
- wear-resistant belts
- knife edge belts
- troughable belts
- ATEX-compliant belts

SPECIAL PROCESSING

Numerous combinations of tension member-design and coating design are possible. But certain conveying and processing tasks require more: mechanical, physical or chemical belt properties which can be provided only by special production processes, combinations of materials and/or finishing (see page 9 and 10).

Brochures 317 and 318 provide information about storing, finishing and fitting, as well as special features and properties. Further information on request.



Profiles/Sidewalls

Conveyor belts with profiles are used for the inclined and declined conveying of bulk goods and small pieces. Profiles are available in various shapes and sizes and can in some cases be supplied as roll material.

To contain goods on the sides when conveying bulk goods, sidewall profiles are used – often in conjunction with lateral profiles.

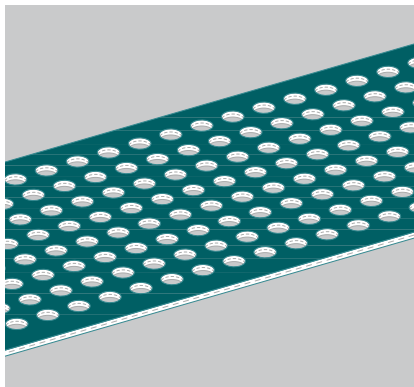

Perforations

It is possible to maintain very narrow tolerances for practically any pattern of perforations in Siegling Transilon material. (Belt material with perforations can not be used for form-fit transmission of power.)



Belt edge sealing

Belt edge sealing prevents oil, grease, water, foreign bodies and bacteria from penetrating the belt. At the same time, it increases the service life of the conveyor belt.

This additional protection can be applied to virtually every Siegling Transilon conveyor belt.

SIEGLING TRANSILON SPlicing TECHNIQUES

Types of splices

The splicing method appropriate for individual applications is dependent on the belt types used and the prevailing operating conditions. In addition to splice reliability, flexibility of the splice and the effort required for fabrication are decisive criteria for the selection of the splicing method. Detailed instructions for all splicing procedures are available on request.

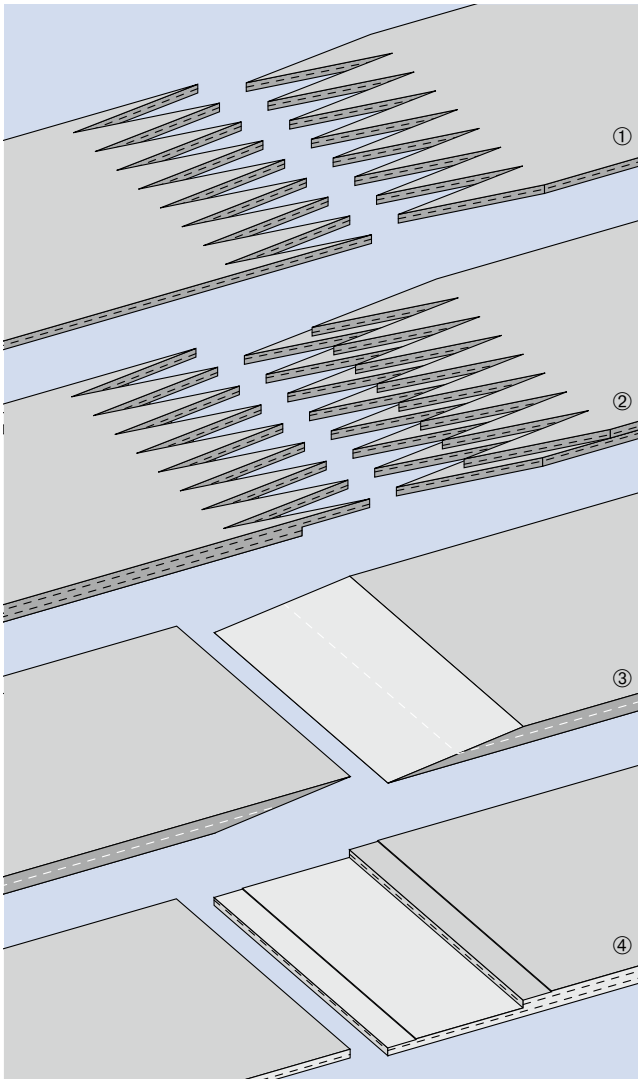

Hot-pressing

A hot-pressed splice provides the highest durability and flexibility. Following types are available:

① Z-splice

Meets the most rigorous of requirements for uniformity of thickness. Very flexible splice, required particularly for knife edge belts. Standard splice for 1 and 2-ply belt-types.

② Stepped Z-splice

Properties comparable to those of the Z-splice. Also suitable for rugged operating conditions (e.g. soiled drums). Possible for various 2 and 3-ply belt types.

③ Wedge splice

Splice type for solid-woven fabric and NOVO types.

④ Stepped overlap splice

Especially for 2 and 3-ply belt types with duroplastic coatings.

Cold-pressing

It is possible to cold-press wedge or stepped overlap splices in independent fitting repair jobs on site. Please note that such splices have limited strength and flexibility.



Mechanical fasteners

Mechanical fasteners make it possible to

- quickly fit and remove the belt without disassembling machine components,
- repair a belt at short notice by inserting a piece of belt material,
- make belts endless quickly and easily (please inquire about lacers).

Following fasteners are available:

- ⑤ **Wire hook fasteners (HS)**
- ⑥ **Clamp fasteners (CS)**
- ⑦ **Plastic fasteners (KS),**
also available optionally imbedded or heated into the belt coating.

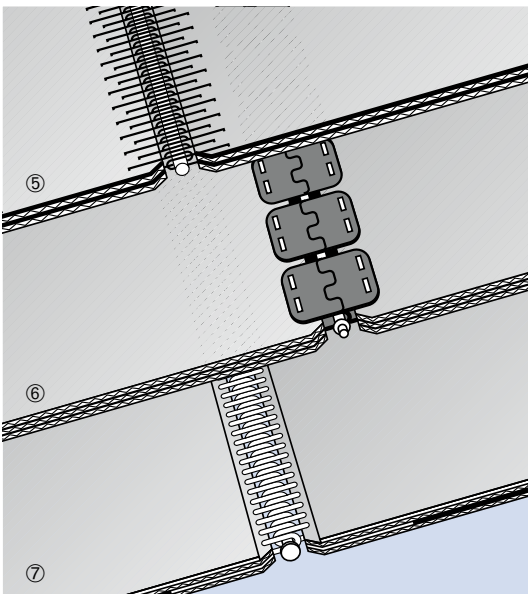

Splicing Equipment

For reliable hot-pressing (splicing) of Siegling Transilon conveyor and processing belts, a diverse, tried-and-tested range of equipment is available.

The equipment required for splicing depends mainly on the type of splice. Other important factors include the conditions under which the splice is to be fabricated (workshop or on-site fitting) and the width of the belts to be spliced.

www.forbo-siegling.com > Products > Tools, Accessories and Training



SIEGLING TRANSILON FURTHER BROCHURES

Application brochures (sectors)

- 193 Tyre Industry
- 194 Metalworking
- 28 Tobacco
- 232 Conveyor and timing belts
for drag band conveyors
- 242 Airports
- 262 Wood
- 263 Sports
- 266 Logistics
- 269 Food
- 295 Textiles – Nonwovens

Overview of the product range

- 215 Siegling Transilon – Standard product range
- 229 Siegling Transilon round belts

Technical Information

- 304 Siegling Transilon –
Calculation methods for conveyor belts
- 305 Siegling Transilon –
Recommendations for machine design
- 317 Siegling Transilon – Technical information 1
(Storage, Finishing, Fitting)
- 318 Siegling Transilon – Technical information 2
(Special features and properties)

SIEGLING TRANSILON **PRODUCT RANGE**

Normally you would find our 16-page Siegling Transilon product range with details on all standard types here. If required, you can order it by quoting reference number 215, or download it as a PDF file at:



www.forbo-siegling.com > Downloads

The **Transilon Product Finder** is an easy way of selecting belts. This app offers users the opportunity to find the right Transilon/processing belt for their application from the Transilon range.



www.forbo-siegling.com > E-tools

Siegling – total belting solutions

Committed staff, quality-orientated organisation and production processes ensure the constantly high standards of our products and services. The Forbo Siegling Quality Management System is certified in accordance with ISO 9001.

In addition to product quality, environmental protection is an important corporate goal. Early on we also introduced an environmental management system, certified in accordance with ISO 14001.



Ref. no. 224-2
02/17 - PV - Reproduction of text or parts thereof only with our approval. Subject to change.



Forbo Siegling service – anytime, anywhere

The Forbo Siegling Group employs more than 2,200 people. Our products are manufactured in nine production facilities across the world. You can find companies and agencies with warehouses and workshops in over 80 countries. Forbo Siegling service points are located in more than 300 places worldwide.

Forbo Siegling GmbH

Lilienthalstrasse 6/8, D-30179 Hannover
Phone +49 511 6704 0, Fax +49 511 6704 305
www.forbo-siegling.com, siegling@forbo.com



MOVEMENT SYSTEMS